

Panasonic welcomes you to our ever growing family of electronic product owners. We know that this product will bring you many hours of enjoyment. Our reputation is built on precise electronic and mechanical engineering, manufactured with carefully selected components and assembled by people who take pride in their work. Once you discover the quality, reliability, and value we have built into this product, you too will be proud to be a member of our family.

Use This Equipment Safely When Driving

Keep the volume level low enough to be aware of road and traffic conditions.

When Car Washing

Do not expose the equipment, including the speakers and CDs, to water or excessive moisture. This could cause electrical shorts, fire, or other damage.

When Parked

Parking in direct sunlight can produce very high temperatures inside your vehicle. Give the interior a chance to cool down before switching the unit on.

Use the Proper Power Supply

This equipment is designed to operate off a 12 volt, negative ground battery system (the normal system in a North American car.)

Protect the Compact Disc Mechanism

Avoid insertion any foreign matters to the slot of the compact disc.

Failure to observe this may cause malfunction due to precise mechanism of this unit.

Use Authorized Servicenters

Do not attempt to disassemble or adjust this precision equipment. Please refer to the Servicenter list included with this product for service assistance.

Note:

This operating instruction manual is for 2 models CQ-DP738EU and CQ-DP728EU. All illustrations throughout this manual represent model CQ-DP738EU unless otherwise specified. The following table describes the differences between 2 models.

Model	Operating Controls			
	Power Output	CD Changer Control	Telephone mute	Security Indicator ON/OFF
CQ-DP728EU	25W×4	No	No	No
CQ-DP738EU	35W×4	Yes	Yes	Yes

Find the model number and serial number on either the back or bottom of the unit. Please record them in the space below and retain this booklet as a permanent record of your purchase to aid in identification in case of theft.

MODEL NUMBER CQ-DP738/728EU

SERIAL NUMBER _____

DATE PURCHASED _____ FROM _____

Contents

Use This Equipment SafelyPage 2

Laser Products.....4

Power and Sound Controls5

How to adjust the volume, Tone Enhancement, Attenuator, balance, and tone for best listening



Radio Basics8

Manual and automatic tuning, band selection, preset stations

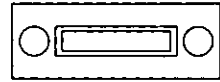

Compact Disc Player Basics10

Mode selection, play repeat, random and scan



CD Changer Basics (Only for CQ-DP738EU)12

Play, repeat, random and scan

Note:

CD changer controls are applicable to units with optional CD changer unit (sold separately).



Clock Basics14

Initial time setting, resetting the time, selecting the clock display

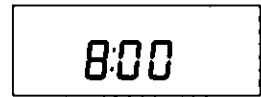

Remote Control Unit Basics15

Battery replacement, notes and Operating procedures.

Installation Guide18

Step-by-step procedures, anti-theft system, electrical connections

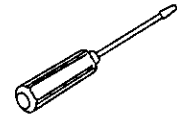

Troubleshooting28

Error messages, troubleshooting tips, where to get service help

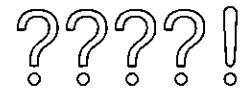

Special Notes30

Notes on compact discs, a caution on new discs

Specifications31

Laser Products (The standard described on this page is for U.S.A. only.)

Caution:

This product utilizes a laser.
Use of controls or adjustments or performance of procedures other than those specified herein may result in hazardous radiation exposure.

Laser products:

Wave length 780 nm

Laser Power No hazardous radiation is emitted with safety protection.

• **Label indications and their locations**

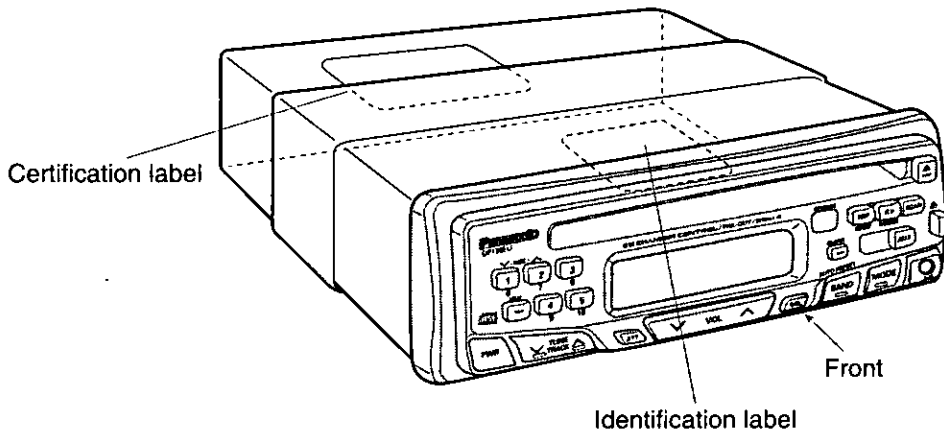

Certification Label

Product complies with DHHS Rules 21 CFR, Subchapter J in effect as of date of manufacture.
Matsushita Communication Industrial Co., Ltd.
Yokohama, Japan

MANUFACTURED

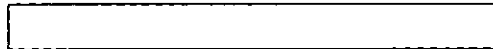

Identification Label

Model No.
N° De Modèle

CQ-DP738EU

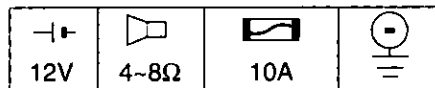

Manufactured by Matsushita Communication Industrial Co., Ltd. Yokohama Japan
Made in Japan

Power and Sound Controls

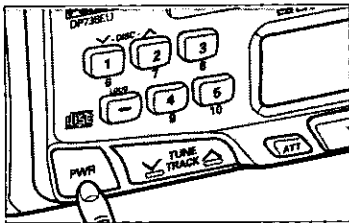
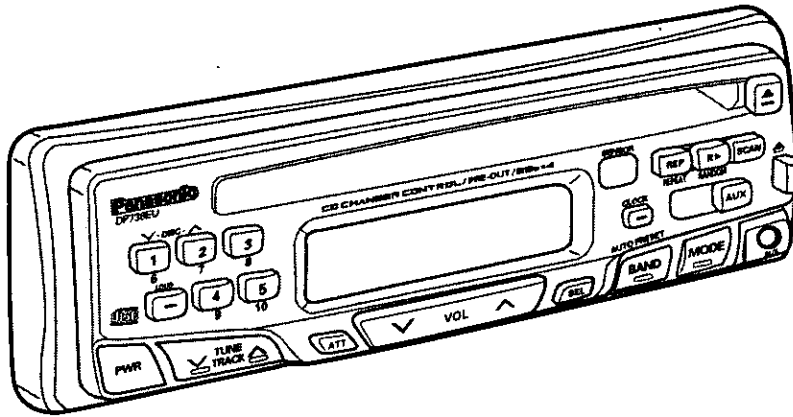

Power

If the car is not already running, turn the key in the ignition until the accessory indicator lights.
Press PWR to switch on the power.

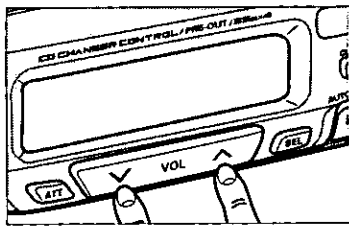

Volume

Press "VOL^" or "VOL∨" to increase or decrease volume.

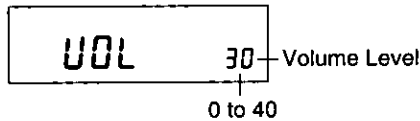

Press "VOL^" or "VOL∨" for more than a half second to change numeric levels on the display rapidly.

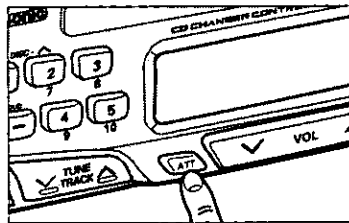

Attenuator

- Press ATT. Volume will decrease to about 1/10 of its previous level.
- Press ATT again to deactivate when listening at normal volume.

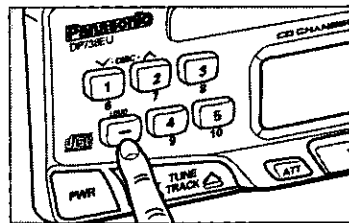
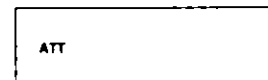

Tone Enhancement

Press LOUD(☐) to enhance bass and treble tones when listening at low or medium volume. Press LOUD(☐) again to deactivate.



Note: This unit is equipped with an anti-volume-blast circuit which serves as an automatic volume level adjuster so that you will not be deafened sudden loud volume. This system operates as follows. When PWR is switched on, the volume level is low. After that, the volume level gradually returns to its previous level prior to switching off the unit.

Power and Sound Controls continued

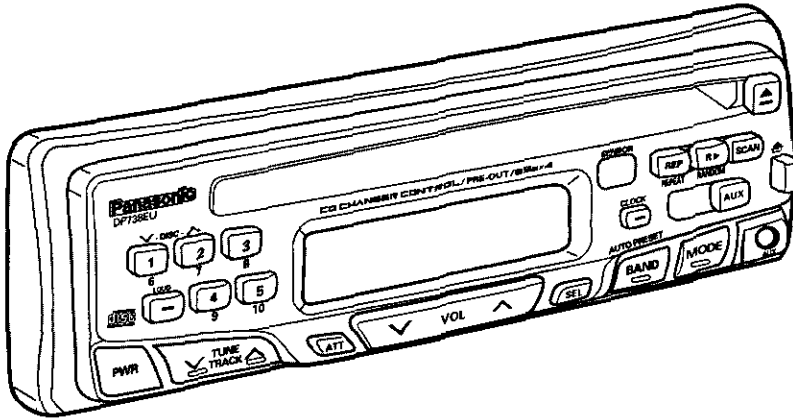

Changing Audio Modes

Press SEL to switch the audio mode in the following order.

VOLUME → BASS → TREBLE
 ↓ ↓
 FADER BALANCE

Bass and Treble

- Press SEL to select the BASS (TREBLE) mode. Press "VOL^" or "VOLv" to increase or decrease the bass/treble response.



- Press "VOL^" or "VOLv" for more than a half second to change numeric levels on the display rapidly.

Balance

- Press SEL to select the BALANCE mode. Press "VOL^" or "VOLv" to shift the sound volume to right or left speakers.

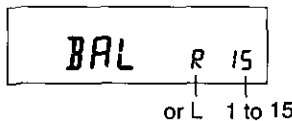

- Press "VOL^" or "VOLv" for more than a half second to change numeric levels on the display rapidly.

Fader

- Press SEL to select the FADER mode. Press "VOL^" or "VOLv" to shift the sound volume to the front or rear speakers.

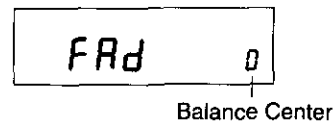
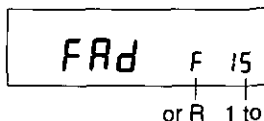

- Press "VOL^" or "VOLv" for more than a half second to change numeric levels on the display rapidly.

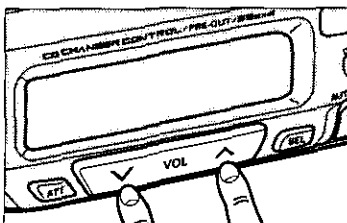
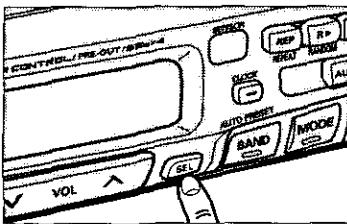
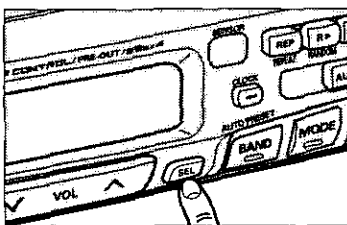

Note: When a control mode (BAS/TRE/BAL/FAD) is selected but no operation is made within 5 seconds, the display will return to the normal operation (volume adjustment) mode. In such a case, press SEL again to select the next control mode.

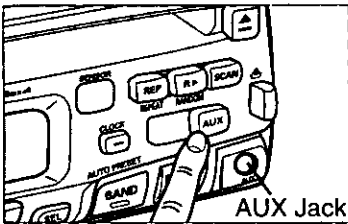

Selecting Auxiliary Source

- Press AUX to select AUX Input mode.

AU In

- Connect the auxiliary equipment (an optional DCC player deck or any other appropriate equipment) to the AUX Jack.

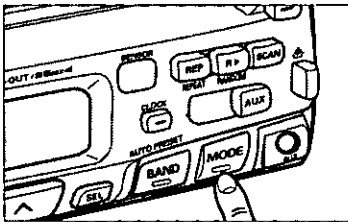

Canceling AUX Input mode

Press AUX or MODE again while the AUX mode is operated, the mode will return to the previous mode. Or insert a CD and the mode will change to CD mode.

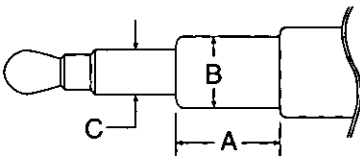

Caution:

In order to insert the plug into the "AUX" Jack properly, make sure to use the correct size of the stereo plug shown on the left.

A-MIN 1/2" LONG (12mm)

B-MAX 2/5" DIA. (10mm)

C-MIN 1/8" DIA. (3.5mm)

Radio Basics

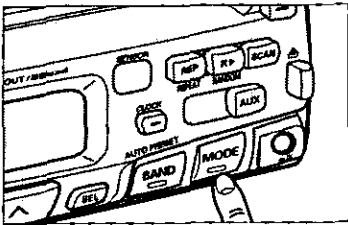
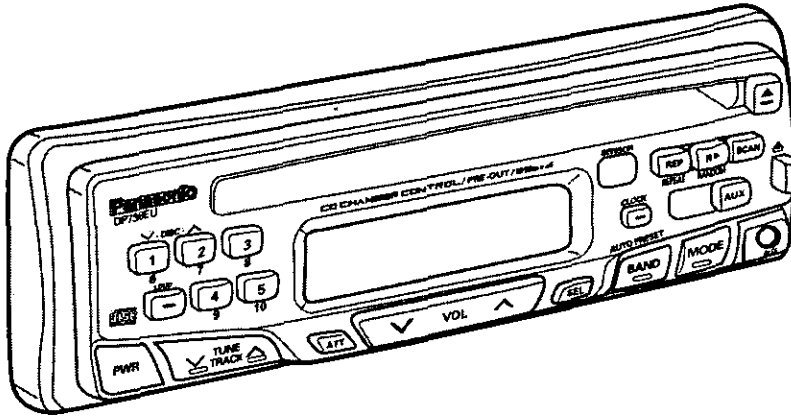

To change Tuner Mode

Tuner mode is selected if the MODE button is pressed in either CD Player, CD Changer Control modes (only for CQ-DP738EU).

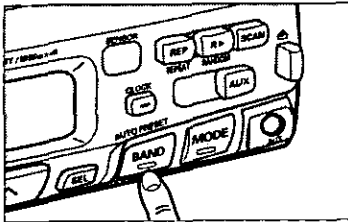
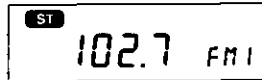

Selecting a Band

Press BAND to select the bands in the following order.

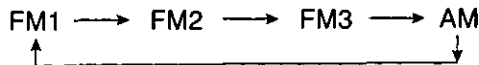

“ST” indicator lights if the station is broadcasting in stereo.

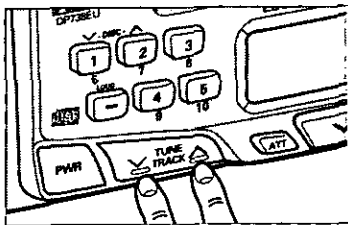

Manual Tuning

Press “^TUNE” or “vTUNE” to move to a higher or lower frequency.

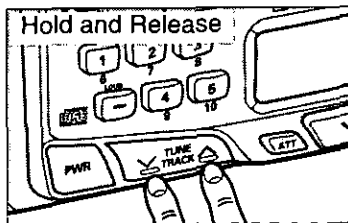

Seek Tuning

Press and hold “^TUNE” or “vTUNE” for more than a half second, then release. The radio automatically stops on the next station.

Preset Station Setting

Up to 20 stations can be preset in the station memory as follows;

FM1	FM2	FM3	AM
5 stations	5 stations	5 stations	5 stations

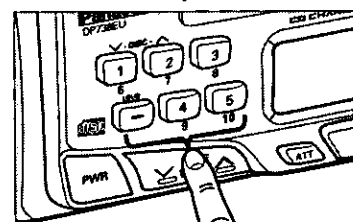
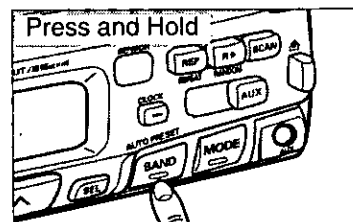
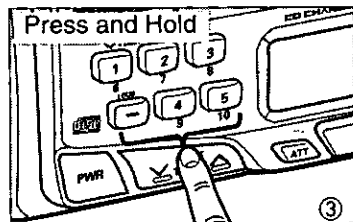
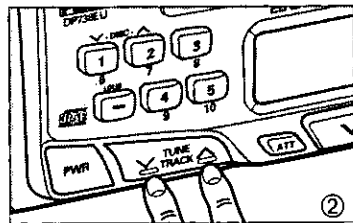
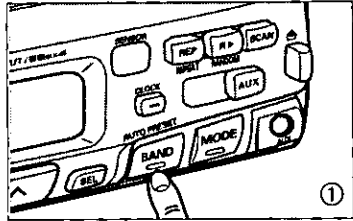

Manual Station Preset

- ① Press BAND to select a desired band.
- ② Use manual or seek tuning to find a station that you want to program into memory.
- ③ Press and hold one of the station selector buttons 1 through 5 until the display blinks.
Repeat the process to set other stations for the FM1 to AM bands.

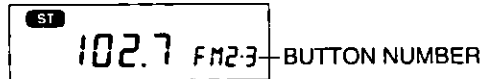

Note; You can change the memory setting by repeating the above procedure.

Tuning in a Preset Station

Press any of the buttons 1 through 5 to tune in the station preset by the above steps ① to ③.

Auto Station Preset

Select a band and press and hold BAND (AUTO PRESET) for more than 2 seconds.

- The five strongest available stations will be automatically set in memory preset buttons 1 through 5.
- Once set, the preset stations are sequentially scanned for 5 seconds.
- Press the appropriate preset button for the station you want to hear.

Caution: For safety reasons, do not attempt to program while driving.

Compact Disc Player Basics

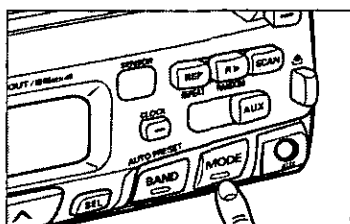
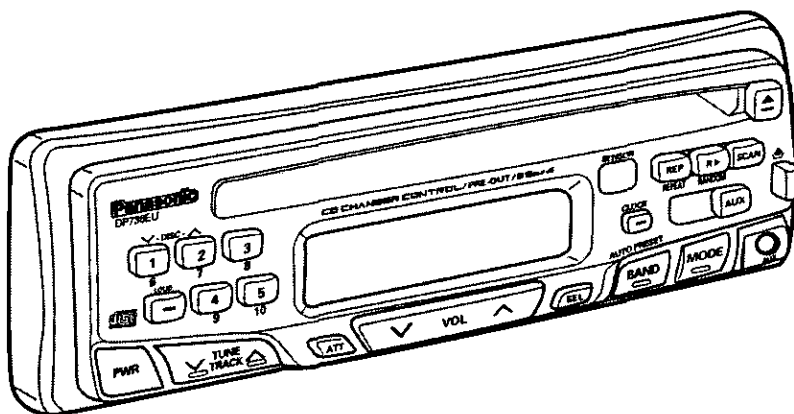

Mode Selection

While the disc is inserted, press MODE to switch the operation mode in the following order.

<For CQ-DP738EU> Tuner → CD Player → CD Changer Control
<For CQ-DP728EU> Tuner ↔ CD Player

To start the CD Player

Insert the disc (label side up) and playback starts automatically.



LOAD

"LOAD" will be displayed until the disc is loaded. Play starts from first track.



Note: While the disc is inserted, "o" indicator will light. If you press "MODE" after the disc is ejected, the disc will be re-inserted.

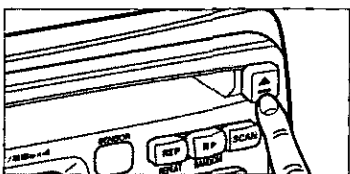

Stopping and Ejecting a Disc

Press "▲" to stop CD play, and the disc will quietly eject from the CD slot. (During disc ejection, "EJ" will be displayed.)

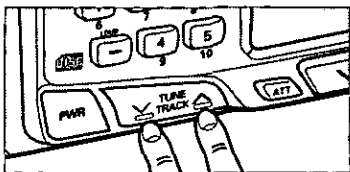

Selecting a Track

Press "TRACK^" once to go to the next track. Press repeatedly to step forward through all the tracks.

Press "▽TRACK" once to play from the beginning of the track you are listening to. Press twice to play the previous track. Press repeatedly to step backward through all the tracks.

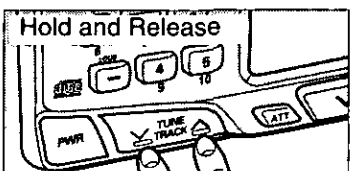

Searching a Track

Press and hold "TRACK^" or "▽TRACK" for more than a half second to activate fast forward or reverse through a track.

Release "TRACK^" or "▽TRACK" to resume the normal CD play from that position.

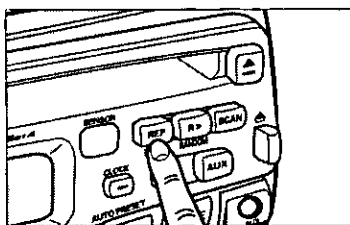

Repeating a Track

Press REP to repeat the current selection. "REPEAT" indicator will light.

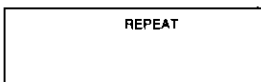

The current selection will continue to repeat until you press REP again.

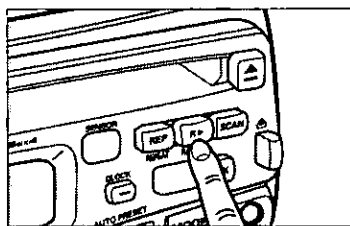

Random Selection

Press R▶. "RANDOM" indicator will light. A random selection of music is played from all available tracks.



To turn off the random play feature, press R▶.

Notes:

- If REP is pressed during random play, the track now in play automatically returns to its beginning upon coming to the end and plays back again. (Random repeat)

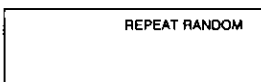

- When REP is pressed again, repeat play stops and returns to random play.
- Press R▶ again, random play stops and repeat play starts.

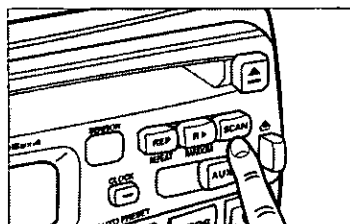

Scanning a Disc

Press SCAN. The display will blink and the first 10 seconds of each track on the disc play in order.

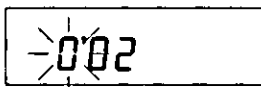

To stop scanning and continue with the current track, press SCAN again.

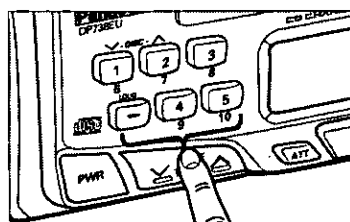

Selecting by Track Number (Direct access)

- Press a number from "1" to "5" then the corresponding track will start.
- Press and hold a number from "6" to "10" ("1" to "5") for more than one second and the corresponding track will start.

CD Changer Basics (Only for CQ-DP738EU)

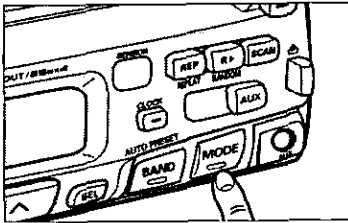
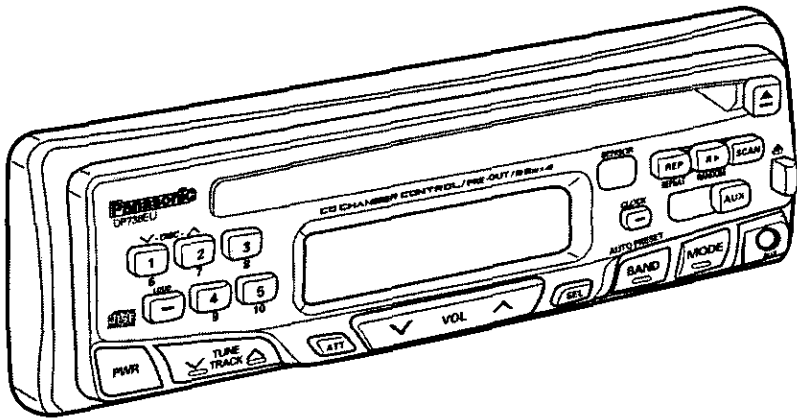

To start the CD Changer

With a disc magazine inserted in the CD Changer, press MODE. Play starts from first track.

[Only for CX-DP600EUC,
CX-DP2000EU]

[Only for CX-DP15EU]

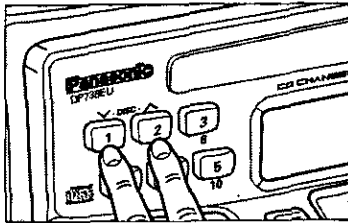
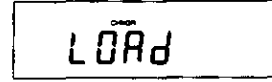
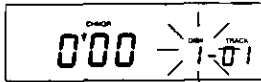

Selecting a Disc

Press "Disc∨" or "Disc∧" to select discs in descending or ascending order. Display shows as follows until the selected disc is loaded. Play starts from first track.

[Only for CX-DP600EUC, CX-DP2000EU]



[Only for CX-DP15EU/EC]

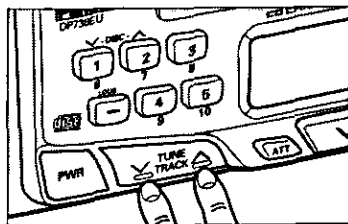
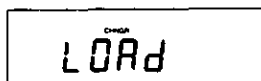

Selecting a Track

Press "TRACK∧" once to go to the next track. Press repeatedly to step forward through all the tracks.

Press "∨TRACK" once to play from the beginning of the current track. Press twice to play the previous track. Press repeatedly to step backward through all the tracks.

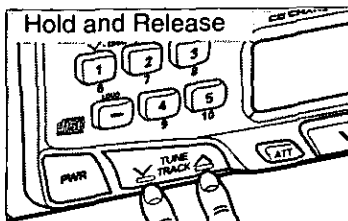

Searching a Track

Press and hold "TRACK∧" or "∨TRACK" for more than a half second to activate fast forward or reverse through a track. Release "TRACK∧" or "∨TRACK" to resume the normal CD play from that position.

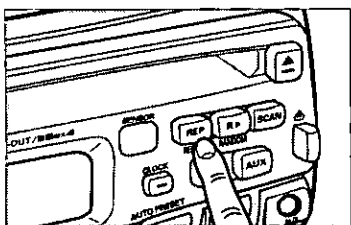

Repeating a Track

Press REP to repeat the current selection. "REPEAT" indicator lights.

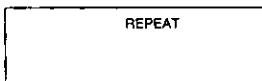

The current selection continues to repeat until you press REP again.

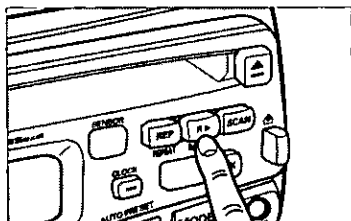

Random Selection

Press R ►. "RANDOM" indicator will light. A random selection of music is played from all available tracks.

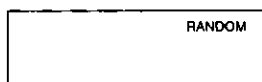

To turn off the random play feature, press R ► again.

Note:

- If REP is pressed during random play, the track now in play automatically returns to beginning upon coming to the end plays back again. (Random repeat)

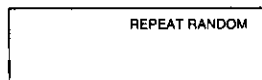

- When REP is pressed again, repeat play stops and returns to random play.
- Press R ► again, random play stops.

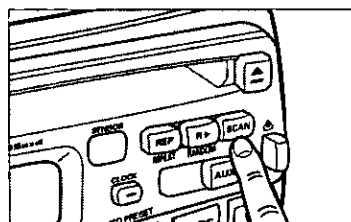

Scanning Tracks

Press SCAN. The display blinks and the first 10 seconds of each track on the discs play in sequence.

To stop scanning and continue with the current track, press SCAN again.

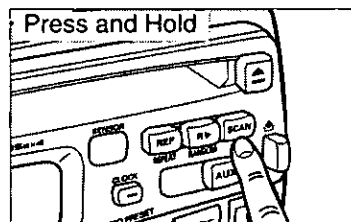

Scanning Discs

Press and hold SCAN for more than 2 seconds. The 1st track of all the discs in the magazine is played for 10 seconds each. Also, Disc Number is displayed at the same time. To stop the current play of the disc scanning, press and hold SCAN for more than 2 seconds again.

Changing the Display (only for CX-DP15EU)

Press CLOCK to switch the display in sequence as follows.

Disc / Track Number

↑
↓
Track Play Time

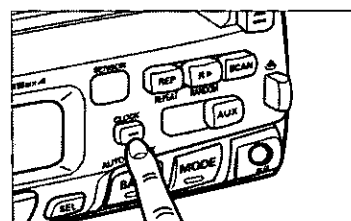

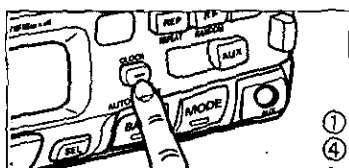
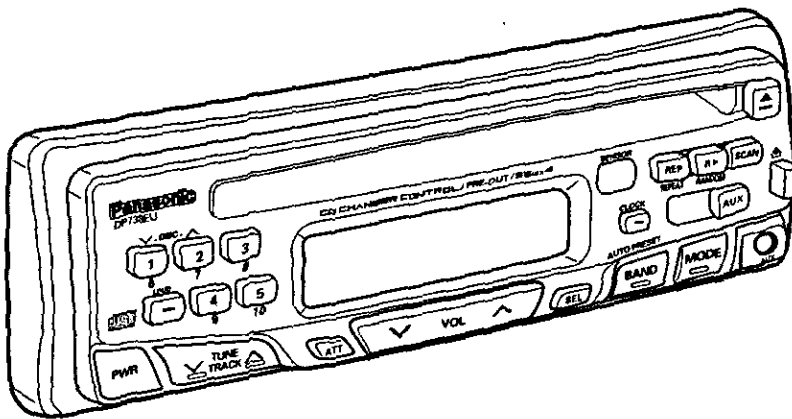

Clock Basics (The clock system is 12-hours.)

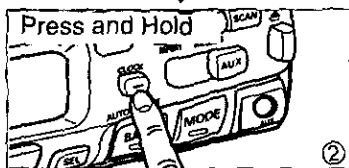
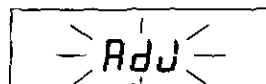

Initial Time Setting

① Press CLOCK(). "AdJ" is displayed.



② Press and hold CLOCK() again for more than 2 seconds, "12" blinks indicating the time setting mode is activated.

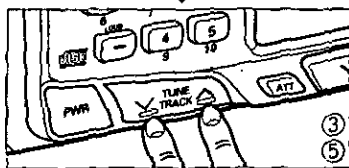
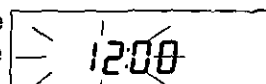

③ To set hours, press "√TUNE" or "TUNE^".

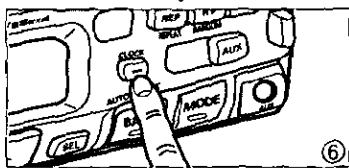
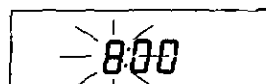

④ Press CLOCK() again for minute setting.

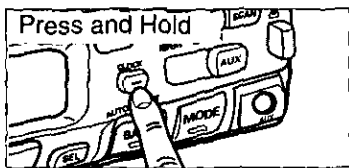
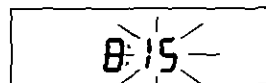

⑤ To set minutes, press "√TUNE" or "TUNE^". Hold "^" or "√" to change numbers rapidly.

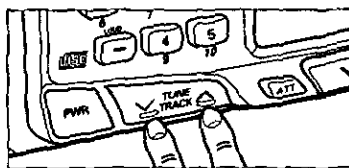
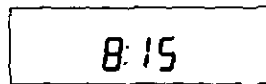

⑥ When you have set the time, press CLOCK().

Resetting the Time

When you want to reset the time, press CLOCK() for more than 2 seconds to activate the time setting mode. Then, repeat step ③ to ⑥ above.

Selecting the Clock Display

Press CLOCK() for click display.

Press CLOCK() once again, the current audio display mode resumes.

Remote Control Unit Basics

Battery Replacement (Remote Control Unit)

1. Remove the battery holder.
Pull the holder by the Position B while pushing Position A in the direction indicated by the arrow.
2. Replace the battery.
Set a new battery properly with the (+) side up as illustrated.
3. Insert the battery holder.
Push in the holder to the full.

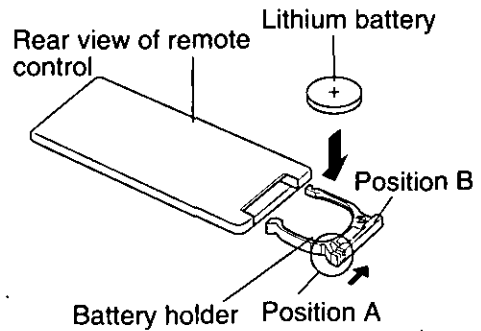

Notes on Batteries

Old batteries must immediately be removed and disposed.

Battery Information:

- Designated Battery: Panasonic Lithium Battery (CR2025)
- Battery Life: 6 months with normal use (in normal room temperature)

Caution:

Improper use of batteries may cause overheating, explosion or ignition, resulting in injury or fire.
Battery leakage may cause damage to the unit.

- Do not disassemble or short the batteries. Do not throw the batteries into the fire.
- To avoid the risk of accident, keep the batteries out of reach of children.

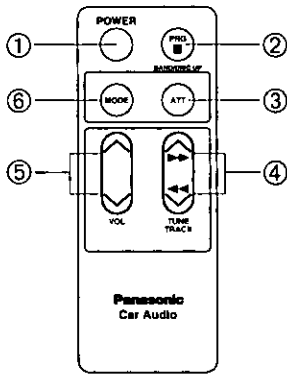

- ① Power Button
- ② BAND/DISC UP Button
- ③ ATT Button
- ④ TUNE/TRACK Button
- ⑤ Volume Control Button
- ⑥ Mode Button

Operating Procedures

Compact Disc Player

(When a disc is inserted, playback starts.)

To start CD Play

⑥MODE (MODE Button)

- Only when a disc is inserted, press to select CD play mode, and playback starts automatically.
- When connecting with the CD changer, press repeatedly to select the mode as follows.

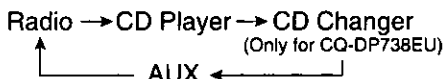

When a disc is inserted, the CD play starts automatically regardless what mode you are being listened.

Selecting a Track

④∨TRACK∧ (Track Select Button)

- Press “∧” once to go to the next track.
- Press “∨” once to play from the beginning of the currently played track.
- Press repeatedly to skip forward or backward through all the tracks.

Searching a Track

④∨TRACK∧ (Track Search Button)

Press and hold “∨” or “∧” for more than a half second to activate fast forward or reverse through a track.

CD Changer Control (Only for CQ-DP738EU)

(In connection with the CD changer.)

To Start the CD Changer

⑥MODE (Mode Button)

When connecting with CD Changer, press MODE to select CD Changer Control Mode, and playback starts automatically.

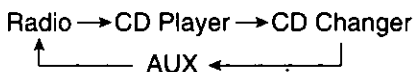

Searching a Track

④∨TRACK∧ (Track Search Button)

- Press and hold “∨” or “∧” for more than a half second to activate fast forward or reverse through the disc.
- Release to stop fast forward or reverse.

Selecting a Track

④∨TRACK∧ (Track Select Button)

- Press “∧” once to go to the next track.
- Press “∨” once to play from the beginning of the currently played track.
- Press repeatedly to skip forward or backward through all the tracks.

Selecting a DISC

②DISC UP (Disc Select Button)

Press to sequentially advance to the next disc.

Installation Guide



WARNING

The installation information is designed for experienced installers and is not intended for non-technical individuals. It does not contain warnings or cautions of potential dangers in attempting to install this product.

Any attempt to install this product in a motor vehicle by anyone other than qualified installer could cause damage to the electrical system and could result in serious personal injury or death.

□ Overview

This equipment should be installed by a professional. However, if you plan to install this unit yourself, your first step is to decide where to install it. The instructions in these pages will guide you through the remaining steps: (Please refer to "WARNING" statement above).

- Identify and label the vehicle wires
- Connect the vehicle wires to the wires of the power connector
- Install the unit in the dash
- Check the operation of the unit

If you do encounter problems, please consult your nearest professional installer.

Caution: This unit will operate with a 12 volt DC negative ground auto battery system only. Do not attempt to use it in any other system. Doing so could cause serious damage.

Before you begin installation, look for the following items included in the packing with your unit.

- **Warranty Card** Fill this out promptly
- **MSC (in Canada: Panasonic) Servicenter Directory** Keep for future reference in case the unit needs servicing
- **Installation Hardware** Needed for in-dash installation

□ Installation Hardware

No.	Item	Diagram	Qty
①	Mounting Collar		1
②	Plain Washer (5 mmφ)		2
③	Spring Washer (5 mmφ)		2
④	Hex. Nut (5 mmφ)		2
⑤	Rear Support Strap		1
⑥	Hex. Bolt (5 mmφ × 25 mm)		1
⑦	Toothed Lock Washer (5 mmφ)		1
⑧	Mounting Bolt (5 mmφ)		1
⑨	Power Connector		1
⑩	Removable Face Plate Case		1
⑪	Remote Control Unit		1
⑫	Lithium battery		1

☐ Required Tools

You'll need a screwdriver, a 1.5 volt AA battery, and the following:

12 V DC
TEST BULB



ELECTRICAL
TAPE



SIDE-CUT
PLIERS



Cut the connector plug off (leaving the leads as long as possible) so that you can work with individual leads.

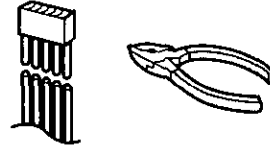

Turn the ignition on to the accessory position, and ground one lead of the test bulb to the chassis.

Touch the other lead of the test bulb to each of the exposed wires from the cut radio connector plug. Touch one wire at a time until you find the outlet that causes the test bulb to light.

Now turn the ignition off and then on. If the bulb also turns off and on, that outlet is the vehicle power lead.

If your vehicle is not wired for an audio unit: Go to the fuse block and find the fuse port for radio (RADIO), accessory (ACC), or ignition (IGN).

Battery Lead

If your stereo unit has a yellow lead, you will need to locate the car's battery lead. Otherwise you may ignore this procedure. (The yellow battery lead provides continuous power to maintain a clock, memory storage, or other function.)

If your vehicle has a radio or is pre-wired for one: With the ignition and headlights off, identify the car battery lead by grounding one lead of the test bulb to the chassis and checking the remaining exposed wires from the cut radio connector plug.

If your vehicle is not wired for an audio unit: Go to the fuse block and find the fuse port for the battery, usually marked BAT.

Speakers

Identify the car speaker leads. There will be two leads for each speaker, usually color coded.

☐ Dashboard Specifications

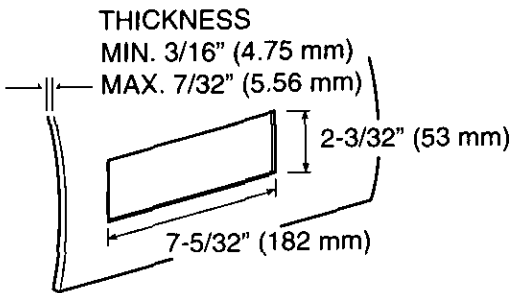

☐ Identify All Leads

The first step in installation is to identify all the vehicle wires you'll use when hooking up your sound system.

As you identify each wire, we suggest that you label it using masking tape and a permanent marker. This will help avoid confusion when making connections later.

Note: Do not connect the power connector to the stereo unit until you have made all connections. If there are no plastic caps on the stereo hooking wires, insulate all exposed leads with electrical tape until you are ready to use them. Identify the leads in the following order.

Power Lead

If your vehicle has a radio or is pre-wired for one:

Installation Guide continued

A handy way to identify the speaker leads and the speaker they connect with is to test the leads using a 1.5 volt AA battery as follows.

Hold one lead against one pole of the battery and stroke the other lead across the other pole. You will hear a scraping sound in a speaker if you are holding a speaker lead.

If not, keep testing different lead combinations until you have located all the speaker leads. When you label them, include the speaker location for each.

Antenna Motor

If your vehicle is equipped with an automatic power antenna, identify the vehicle motor antenna lead by connecting one bulb tester lead to the vehicle battery lead and touching the remaining exposed wires from the cut radio connector plug one at a time. You will hear the antenna motor activate when you touch the correct wire.

Antenna

The antenna lead is a thick, black wire with a metal plug at the end.

Telephone Mute (only for CQ-DP738EU)

If you have a cellular phone, refer to its operator manual to identify the telephone mute lead connection.

Connect All Leads

Now that you have identified all the wires in the vehicle, you're ready to begin connecting them to the stereo unit wires. The connection diagram on Page 27 show the proper connections and color coding of the leads.

We strongly recommend that you test the unit before making a final installation.

You can set the unit on the floor and make temporary connections to test the unit. Use electrical tape to cover all exposed wires.

Important: Connect the red power lead last, after you have made and insulated all other connections.

Ground

Connect the black ground lead of the power connector to the metal vehicle chassis.

Speakers

Connect the speaker wires. See the wiring diagram below for the proper hookups. Follow the diagram carefully to avoid damaging the speakers and the stereo unit.

The speakers used must be able to handle more than 35 watts (for CQ-DP728EU; 25watts) of audio power. If using an optional audio amplifier, the speakers should be able to handle the maximum amplifier output power. Speakers with low input ratings can be damaged.

Speaker impedance should measure 4 - 8 ohms, which is typically marked on most speakers. Lower or higher impedance speakers will affect output and can cause both speaker and stereo unit damage.

Caution: Never ground the speaker cords. For example, do not use a chassis ground system or a three-wire speaker common system. Each speaker must be connected separately using parallel insulated wires. If in doubt about how your car's speakers are wired, please consult with your nearest professional installer.

Motor Antenna

Connect the vehicle motor antenna lead to the blue motor antenna relay control lead.

Battery

Connect the yellow battery lead to the correct radio wire or to the battery fuse port on the fuse block.

Telephone Mute (only for CQ-DP738EU)

Connect the orange telephone mute lead as instructed in your cellular phone operator manual.

Antenna

Connect the antenna by plugging the antenna lead into the antenna receptacle.

Equipment

Connect any optional equipment such as amplifier, according to the instructions furnished with the equipment. Keep about 12 inches (30 cm) of distance between the speaker cords/amplifier unit and the antenna/antenna extension cord. Read the operating and installation instructions for any equipment you will connect to this unit.

Power

Connect the red power lead to the correct vehicle radio wire or to the appropriate fuse port on the fuse block.

If the stereo unit functions properly with all these connections made, disconnect the wires and proceed to the final installation.

Final Installation

Lead Connections

Connect all wires, making sure that each connection is insulated and secure. Bundle all loose wires and fasten them with tape so they won't fall down later. Now insert the stereo unit into the mounting collar.

Congratulations! After making a few final checks, you're ready to enjoy your new auto stereo system.

Final Checks

1. Make sure that all wires are properly connected and insulated.
2. Make sure that the stereo unit is securely held in the mounting collar.
3. Turn on the ignition to check the unit for proper operation.

If you have difficulties, consult your nearest authorized professional installer for assistance.

Installation Guide continued

□ Installation Procedures

1. Secure the Mounting Collar ①.

Insert Mounting Collar ① into the car's dashboard, and bend mounting tabs out with a screwdriver.

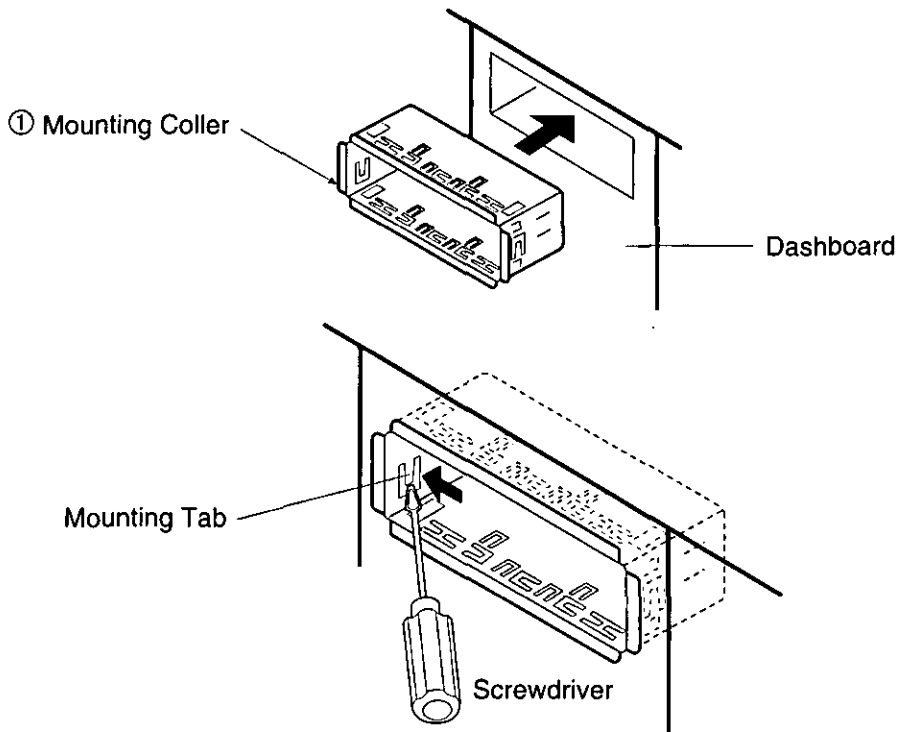

2. Secure the rear of the unit

- a) Check the electrical connection by referring to this operating instructions.
- b) Connect the Mounting Bolt ⑧, using a suitable wrench.

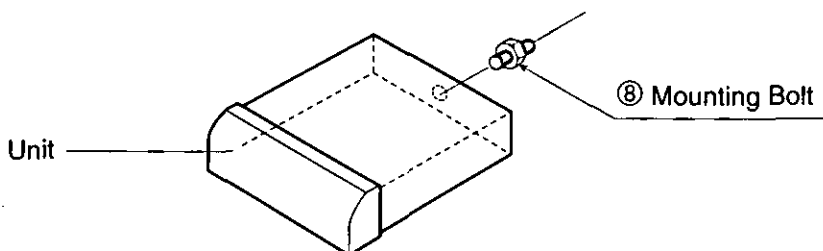

- c) Insert the unit into Mounting Collar ① and push it in until "click" is heard.

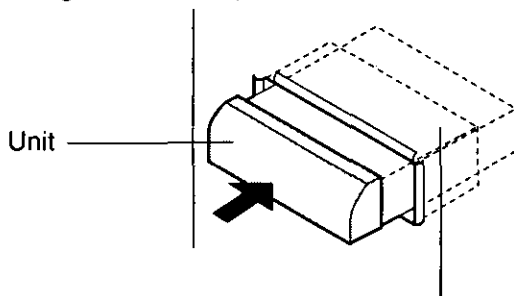

- d) Secure the rear of the unit to the car by either of the two recommended methods on the next page.

■ Using the Rear Support Strap ⑤

Affix one end of the Rear Support Strap ⑤ to the rear of the unit, and the other end to the Fire Wall of Car, or some other metallic area.

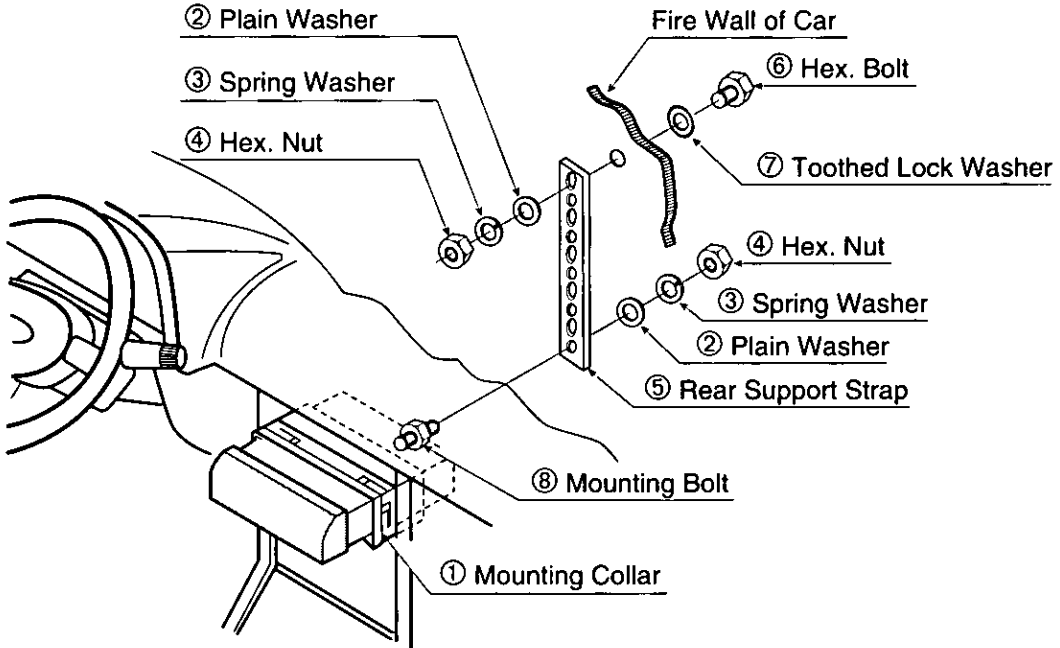

■ Using the Rubber Cushion (Optional)

(If there is an existing Rear Support Bracket on the Fire Wall of Car.)
Cover Mounting Bolt ⑧ on the rear of the unit with Rubber Cushion (Optional), and mount it into existing Rear Support Bracket.

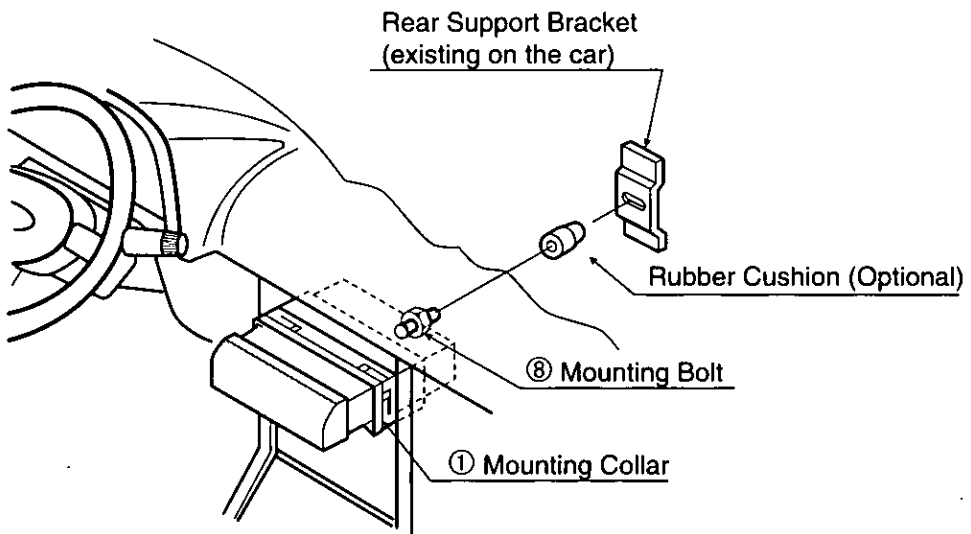

Installation Guide continued

3. Plug the Power Connector ⑨.

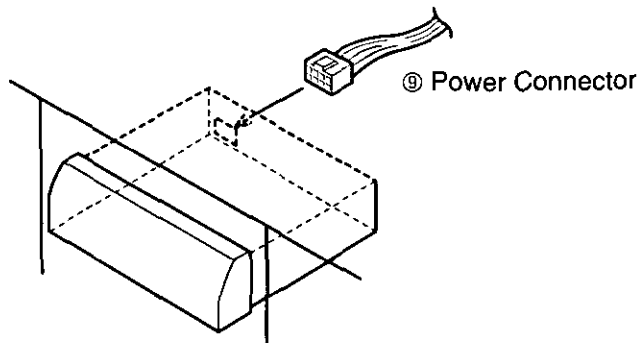

4. After installation reconnect the negative (-) battery terminal.

To Remove the Unit

a) Remove the trim plate with a screwdriver as shown in the figure.

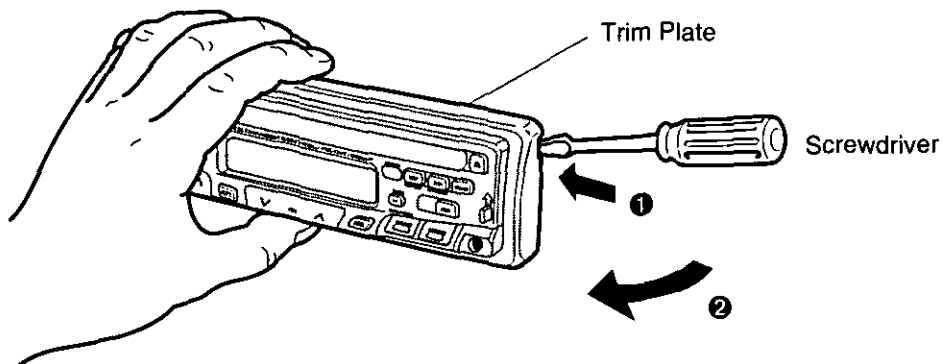

b) Pull out the unit while pushing the lock lever using a screwdriver.

c) Remove the unit pulling with both hands.

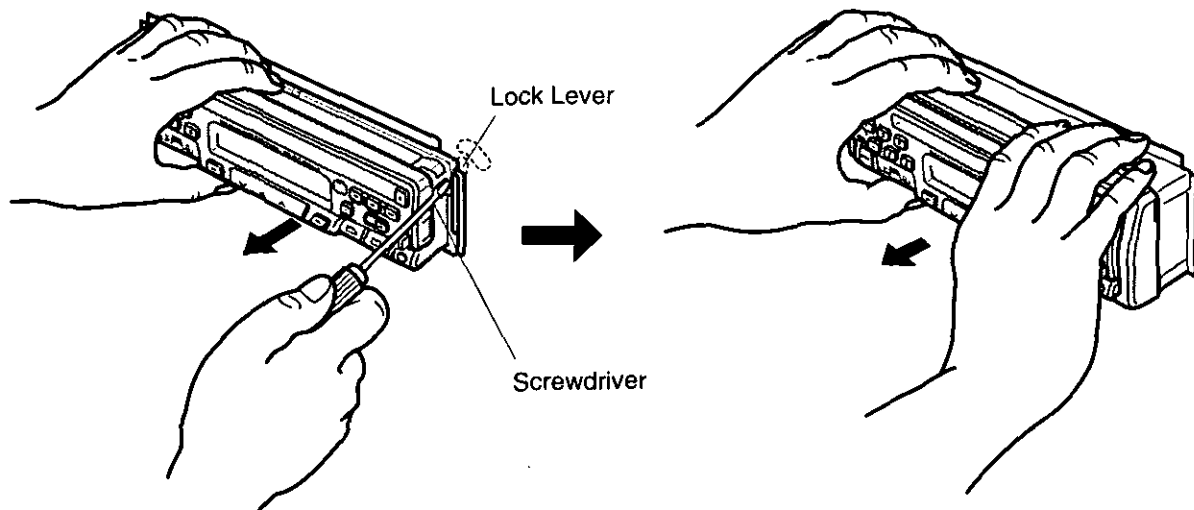

Anti-Theft System

This unit is equipped with a removable face plate. By removing this face plate, the radio becomes totally inoperable. The security indicator will blink.

To Remove the Removable Face Plate

- ① Switch off the power.
- ② Press the release button (▲). The removable face plate will be released.

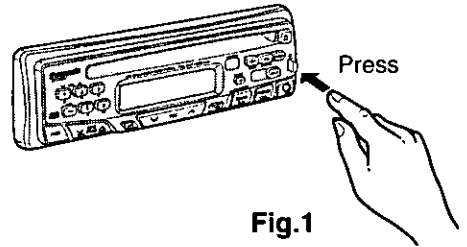

- ③ Remove the removable face plate by pulling on the right side of the unit. Place the removable face plate in a supplied case.

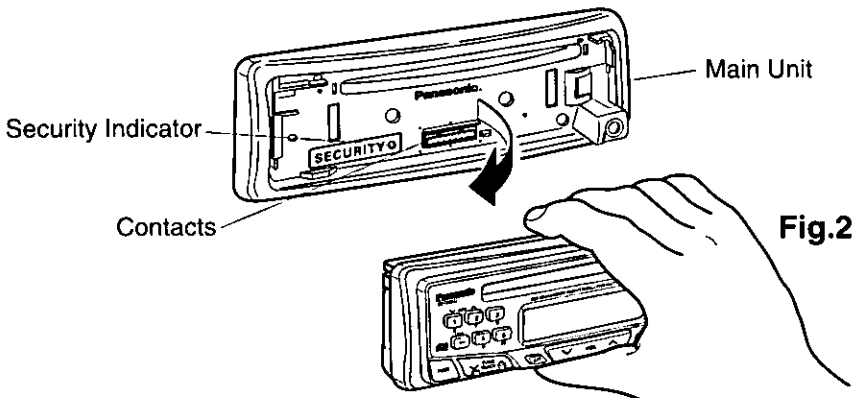

Security Indicator (only for CQ-DP738EU)

The security indicator blinks when the removable face plate is removed from the unit.

Activate Security Indicator (only for CQ-DP738EU)

Press and hold SEL for more than 2 seconds when the power is ON. "LED ON" is displayed, and the security indicator turns ON.

Display		Security Indicator
LED	Disappears	On
↕		Blinks
LED	Disappears	OFF
		(Press and hold SEL for more than 2 seconds.)
		OFF

Caution:

When you want to remove the unit, the security indicator functions can be canceled by the following steps of procedure.

- Install the removable face plate.
- Disconnect the power connector.

Installation Guide continued

- ④ As shown in Fig.3, insert the removable face plate with the arrow pointing toward the removable face plate case until you hear a “click”. Keep the removable face plate in the case. Then, you can bring the plate safety.

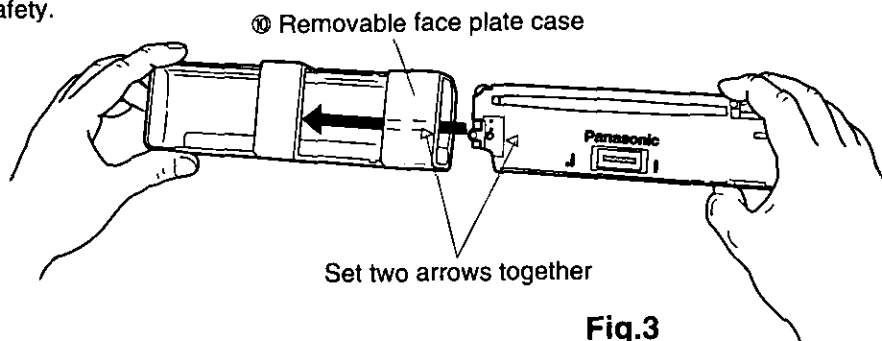

To install the Removable Face Plate

- ① Slide the left side of the removable face plate in place.

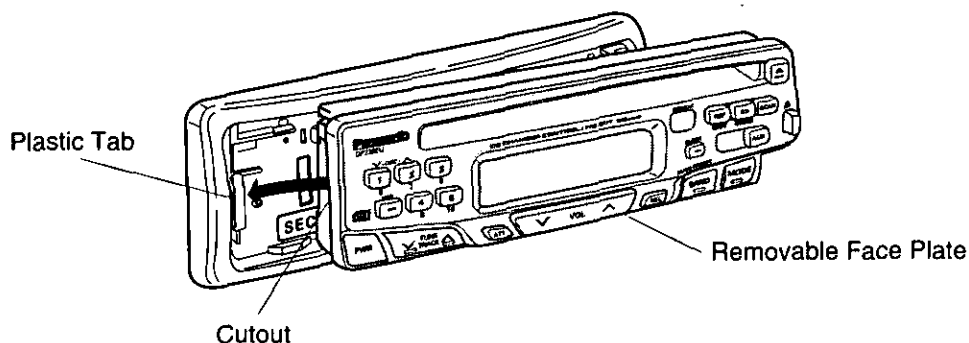

- ② Press the right end of the removable face plate until “click” is heard.

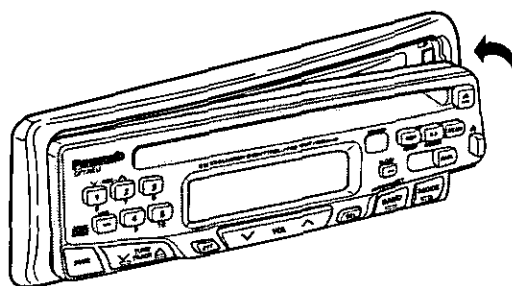

Caution:

1. Before removing the removable face plate, make sure the power is off.
2. This removable face plate is not water-proof. Do not expose it to water or excessive moisture.
3. Do not remove the removable face plate, while driving your car.
4. Do not place the removable face plate on the dashboard or nearby areas where the temperature rises to high levels.
5. Do not touch the contacts on the removable face plate or on the main unit, since this may result in poor electrical contacts.
6. If dirt or other foreign substances get on the contacts, wipe them with a clean, dry cloth.

- This unit can be connected to an optional CD changer (CX-DP600EUC). For details consult your nearest Panasonic dealers.
- For connection to a CD changer, refer to the operating instructions of the CD Changer (CX-DP600EUC).

Caution:

- To prevent damage to the unit, be sure to follow the connection diagram below.
- Remove the covering of the leads about 5 mm long from their end before connecting.
- Do not insert the power connector into the unit until the wiring is completed.
- Be sure to insulate any exposed wires from a possible short-circuit from the car chassis. Bundle all cables and keep cable terminals free from touching any metal parts.

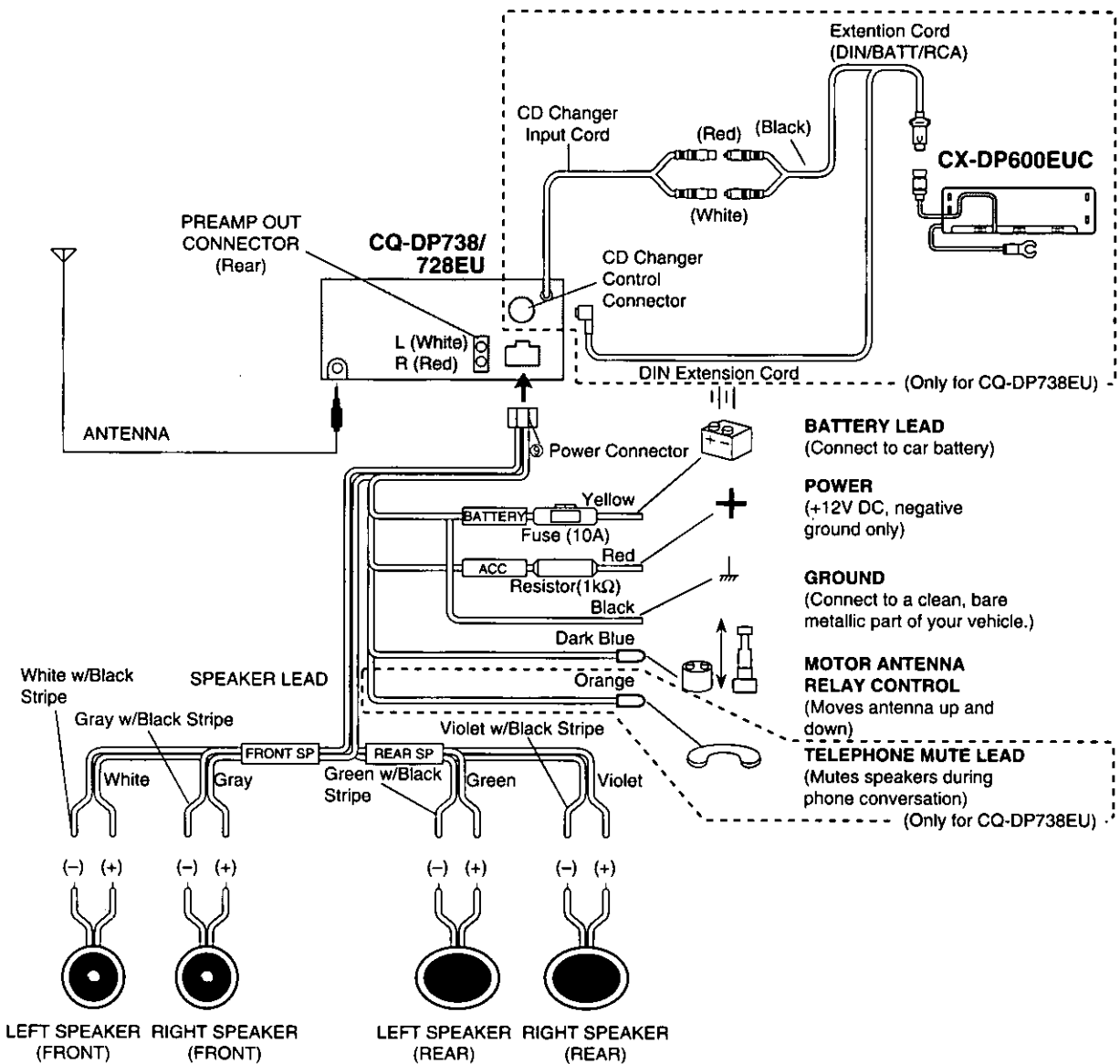

Troubleshooting

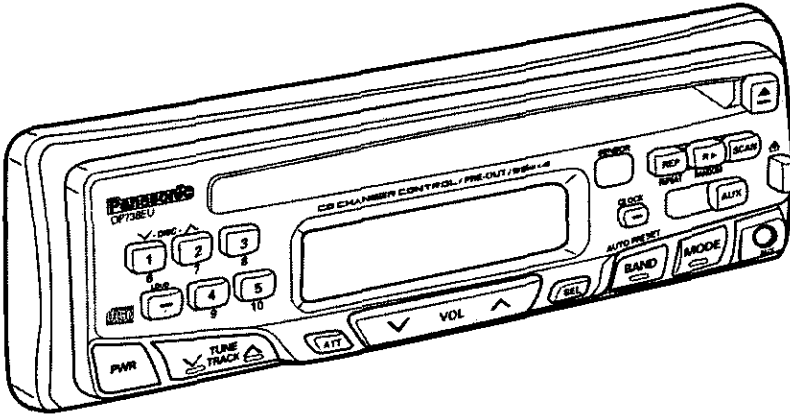

Maintenance

Your product is designed and manufactured to ensure a minimum of maintenance. Use a soft cloth for routine exterior cleaning. Never use benzine, thinner, or other solvent.

When Something Doesn't Work

Check the charts on the next page for possible causes and solutions to any problem you might be experiencing. Some simple checks or minor adjustments may eliminate the problem.

Product Servicing

If the suggestions in the charts don't solve the problem, we recommend that you take it to your nearest authorized MSC (in Canada: Panasonic) Servicenter. The unit should be serviced only by a qualified technician.

Replacing the Fuse

Use fuses of the same specified rating (10 amps). Using different substitutes or fuses with higher ratings, or connecting the unit directly without a fuse, could cause fire or damage to the stereo unit.

If the replacement fuse fails, contact your nearest MSC (in Canada: Panasonic) Servicenter for service.

Error Display Messages

E1	Displays when the compact disc is dirty or upside down. The disc eject automatically.
E2	Displays when compact disc is scratched. The disc eject automatically.
E3	Displays when the compact disc stops operating for some reason. Please turn off the car engine (ACC off) and remove the fuse from yellow lead for 1 minute. Then reinstall the fuse.
0000	Displays when there is no disc in the magazine. (Only for CQ-DP738EU)

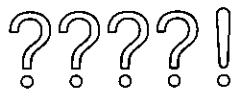

□ Troubleshooting Tips

PROBLEM	POSSIBLE CAUSE	PROBABLE SOLUTION
Unit won't turn on.	Dead vehicle battery. Ignition not on. Bad power line connection. Fuse burned out.	Charge vehicle battery. Turn ignition to On or Accessory. Check connections. Replace fuse.
Radio has static.	Antenna not hooked up.	Hook up antenna.
	Close to high power lines.	Move away from high power lines.
Radio memory buttons don't work.	Not holding buttons down long enough.	Press and hold buttons for more than 2 seconds.
No sound can be heard even if the disc is properly loaded.	The compact disc is inverted.	Insert the disc with label side facing up.
	The compact disc is very dirty.	Try to clean the compact disc by instructions of disc cleaning.
	The temperature inside the car is more than 140°F (60°C).	Give the interior a chance to cool down before using the unit.
	Excessive moisture.	Wait for a while before using the unit.
	Wiring connection is not properly done.	Confirm all wiring connection such as power cord, speaker cords, etc.
	Volume control is at "minimum" position.	Adjust the volume control to the proper level.
	Fuse of amplifier is blown out.	Replace the fuse with the correct rating.
Sound distorted due to vibration.	Installation method is bad.	Fix the unit securely.
Inverted sound (Left/Right connections).	The speaker cords are inverted.	Check the speaker cords.
No sound from front or rear speakers.	The fader control is set on the wrong position.	Adjust the fader control of the unit correctly.
Sound distorted sometimes.	The compact disc may be defective.	Try to replace the disc with another one.
	The compact disc is dirty.	Try to clean the compact disc by instructions of disc cleaning.
A compact disc is sometimes ejected. (Display shows "E1", an error message.)	The pickup lens is dirty.	Clean the lens. (Use CD lens cleaning disc.)

Special Notes

Notes on Compact Discs

USE ONLY DISCS CARRYING THIS LABEL

COMPACT
disc
DIGITAL AUDIO

- Handle discs carefully.
- Keep discs clean.
- Do not scratch or place stickers on discs.
- Do not bend discs.
- Keep discs in their cases when not using them.
- Do not place discs:
 1. In direct sunlight.
 2. In dirty, dusty or damp areas.
 3. Near the vehicle heater.
 4. On the seats or dashboard.

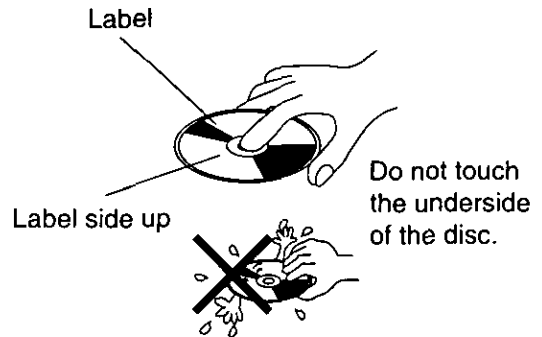

Wipe the disc from center to outside direction.

Disc Cleaning

Use a dry, soft cloth to wipe the surface. If the disc is soiled, use a soft cloth slightly dampened with isopropyl (rubbing) alcohol. Never use solvents such as benzine, thinner, conventional record cleaner, or household cleaners as they may mar the surface of the disc.

A Caution on New Discs

A new disc may have rough spots on its inner and outer edges. These rough edges may cause the CD player to reject the disc. Remove these rough edges by rubbing the inner and outer edges with a pen or pencil as shown at right.

Rough spots on outer edge

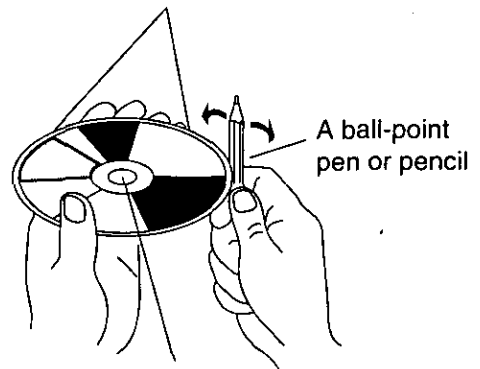

Rough spots on inner edge

Specifications

General

Power Supply:	12 V DC (11 V - 16 V), Test Voltage 14.4 V, Negative ground
Maximum Power Output:	35 W × 4 channels at 400 Hz, Volume Control maximum (CQ-DP738EU) 25 W × 4 channels at 400 Hz, Volume Control maximum (CQ-DP728EU)
EIA Power Output:	14 W per channel into 4 ohms, 20 to 30,000 Hz, at 1% THD (CQ-DP738EU) 9 W per channel into 4 ohms, 20 to 30,000 Hz, at 1% THD (CQ-DP728EU)
Tone Action:	Bass, ±12 dB at 100 Hz, Treble; ±12 dB at 10 kHz
Pre-Amp Output Voltage:	1.4 V (CD Play Mode; 1 kHz 0 dB)
Output Impedance:	600 Ω
Current Consumption:	Less than 1.7 A (CD Play Mode)
Dimensions Main Unit (W×H×D):	7" × 1-15/16" × 5-7/8" (178 × 50 × 150 mm)
Weight Main Unit:	3 lbs 12 oz (1.7kg)

AM Radio

Frequency Range:	530 - 1,710 kHz
Useable Sensitivity:	28 dB/μV (25μV, S/N 20 dB)

FM Stereo Radio

Frequency Range:	87.9 - 107.9 MHz
Useable Sensitivity:	13.2 dBf. (1.25 μV, 75 Ω)
50 dB Quieting Sensitivity:	15.2 dBf. (1.6 μV, 75 Ω)
Frequency Response:	30 - 15,000 Hz ± 3 dB
Capture Ratio:	1.5 dB
Alternate Channel Selectivity:	75 dB
Stereo Separation:	42 dB at 1,000Hz
Image Response Ratio:	75 dB
IF Response Ratio:	100 dB
Signal/Noise Ratio:	70 dB

CD Player

Sampling Frequency:	32 times oversampling
DA Converter:	MASH•1bit/4 DAC System
Error Correction System:	Panasonic Super Decoding Algorithm
Pick-Up Type:	Astigma 3-beam
Light Source:	Semiconductor laser
Wavelength:	780 nm
Frequency Response:	20 Hz to 20,000 Hz, ± 1 dB
Signal/Noise Ratio:	96 dB
Total Harmonic Distortion:	0.01% (1,000 Hz)
Wow and Flutter:	Below measurable limits
Channel Separation:	75 dB

* Above specifications comply with EIA standards.

Note:
Specifications and design are subject to modification without notice due to improvements in technology.

**Matsushita Consumer Electronics
Company, Division of Matsushita
Electric Corporation of America**
One Panasonic Way, Secaucus,
New Jersey 07094

**Panasonic Sales Company.
Division of Matsushita Electric of
Puerto Rico Inc. ("PSC")**
Ave. 65 de Infanteria, Km. 9.5
San Gabriel Industrial Park Carolina,
Puerto Rico 00985